

Quickdraw[®]

CONVEYOR SYSTEMS



1.800.473.8837

www.qdraw.com



ABOUT US

Quickdraw Systems is a global provider of material handling, motion control, and custom manufacturing solutions. Quickdraw is a pioneer of revolutionary material handling solutions for factory and laboratory automation.

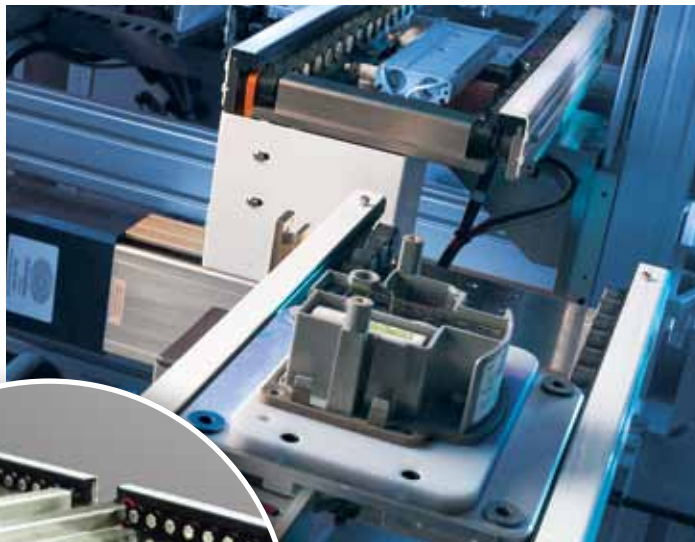

Quickdraw Systems delivers industry-leading clean and modular automation solutions through our line of proprietary material handling and custom motion controlled products.

Quickdraw delivers automated material handling solutions to customers concerned about precision performance. Solving problems is easy with Quickdraw's modular and flexible designs that provide just the right mix of standard and special components. Quickdraw's open center designs allow for ease of transfer, positioning, orientation,

and work processing. Quickdraw provides solutions to factory and laboratory automation markets and a wide range of assembly solutions. A variety of custom or standard sizes are available for efficient, cost-effective product selection, or work with Quickdraw to specify a custom solution to meet your application's need.



LEAN SOLUTIONS





MR



XR



HD

Description:

Quickdraw offers three classes of open-center, slip-roller conveyors: MR, XR, and HD. Each features modularity, low back pressure accumulation, and DC Brushless Motor drives. These clean and quiet conveyors are perfect for integration in automated assembly applications.

The MR is the most compact, lowest profile class of automation conveyor.

The XR is a mid-range conveyor for general purpose automation projects.

The HD is a large class conveyor for handling totes and other heavy loads in accumulation and automation processes.

Speed	Variable up to 90 fpm (27 m/min)	Variable up to 90 fpm (27 m/min)	Variable up to 90 fpm (27 m/min)
Pallet or Part Weight lbs. (kg)	25 (11) static 40 (18) dynamic	60 (27) static 120 (54) dynamic	200 (91) static 400 (181) dynamic
Conveyor Lengths in. (cm)	6 (15), 9 (23), 11 (28), 15 (38), 17 (43), 22 (56), 30 (76), 35 (89), 39 (99), 48 (122), 60 (152)	Up to 120 (305) in 1.5 (3.81) increments	Up to 120 (305) in 2 (5.08) increments
Power Requirements	24 VDC 1 Amp. 110/230 VAC supply available	24 VDC 2 Amp. 110/230 VAC supply available	24 VDC 4 Amp. 110/230 VAC supply available
Features	Bidirectional accumulation Modular Low-profile ESD available	Fast, easy manual width adjustment Bidirectional accumulation Modular	Fast, easy manual width adjustment Bidirectional accumulation Modular
Auxiliary Devices	Metering Stops, Lift & Locate Docks, Lift & Transfer, Corner Transfers, Pallet Loaders/Unloaders, Elevators	Metering Stops, Lift & Locate Docks, Lift & Transfer, Corner Transfers, Pallet Loaders/Unloaders, Elevators	Metering Stops, Lift & Locate Docks, Lift & Transfer, Corner Transfers, Pallet Loaders/Unloaders, Elevators
Typical Applications	Automated and manual processes in palletized assembly Microplate-based laboratory and pharmaceutical processes	Automated and manual processes in palletized assembly Clean Manufacturing	Automated and manual processes in palletized assembly Totes Tooling
Options	Edge Handling Rollers Belt Drive Direct Drive Lowered Drive Powered Rails	Sensor Stops	Wide Rollers Sensor Stops

Quickdraw® conveyor systems for factory automation offer a full line of modular components, both standard and custom, are ideal for micro-electronics, automotive sub-assemblies, medical, laboratory, semiconductor, and many other applications.

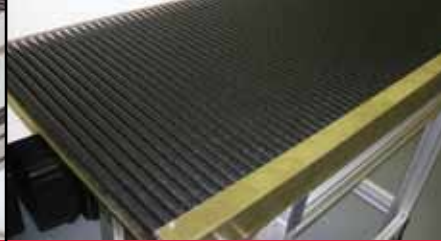

	<i>LR</i>	<i>XLR</i>	<i>Edge-Belt</i>
Description:	<p>Quickdraw's LR and XLR conveyors feature full roller beds across the width of the conveyor. They are well-suited for accumulation of irregular-shaped products of assorted sizes without shingling or damage to packaging.</p> <p>The LR roller bed is comprised of solid rollers and is used for single lane accumulation and transfer. Available in widths up to 18 inches (38 cm).</p>		<p>The XLR roller bed is comprised of many adjacent slip rollers across the roller bed, suitable for multi-lane accumulation. It is unidirectional.</p>
Speed	Variable up to 90 fpm (27 m/min)	Variable up to 90 fpm (27 m/min)	Variable up to 90 fpm (27 m/min)
Pallet or Part Weight lbs. (kg)	25 (11) static 40 (18) dynamic	60 (27) static 120 (54) dynamic	10 (4.5) dynamic
Conveyor Lengths in. (cm)	6 (15), 9 (23), 11 (28), 15 (38), 17 (43), 22 (56), 30 (76), 35 (89), 39 (99), 48 (122), 60 (152)	Up to 120 (305) in 1 (2.54) increments	Up to 58 (147)
Power Requirements	24 VDC 1 Amp. 110/230 VAC supply available	24 VDC 2 Amp. 110/230 VAC supply available	24 VDC 1 Amp. 110/230 VAC supply available
Features	Bidirectional Single-lane accumulation Modular	Multi-lane accumulation Modular	Meets SMEMA physical standards, SMEMA communication available, Bidirectional, Modular, ESD
Auxiliary Devices	Metering Stops, Locate Nests	Metering Stops, Locate Nests	Metering Stops, Locate Nests, Stackers/De-Stackers, Magazine Loaders/Unloaders
Typical Applications	Blow-molded parts trays Accumulating delicate packages	Accumulating delicate packages Multi-lane pack out	Built-in SMEMA communication
Options/Other Info	Adjustable Product Guides Sensor Stops	Adjustable Product Guides Sensor Stops	Programmable automatic adjustable width Board clamps Multi-zone

CLEAN, MODULAR, COMPACT CONVEYOR SYSTEMS

State-of-the-art Quickdraw Conveyor Systems were specially designed for use in automation processes. Their patented low profile, open center, slip-roller design can easily be integrated with an endless variety of automation processes. This flexible, modular design makes them an ideal selection for conveyance in cleanroom environments, automotive component assembly, medical device and instrument assembly, microelectronics production, and semiconductor applications. And, with conveyors available for low to high range load capacities paired with bidirectional operation and compatibility with a variety of auxiliary devices, Quickdraw meets your most challenging production needs.

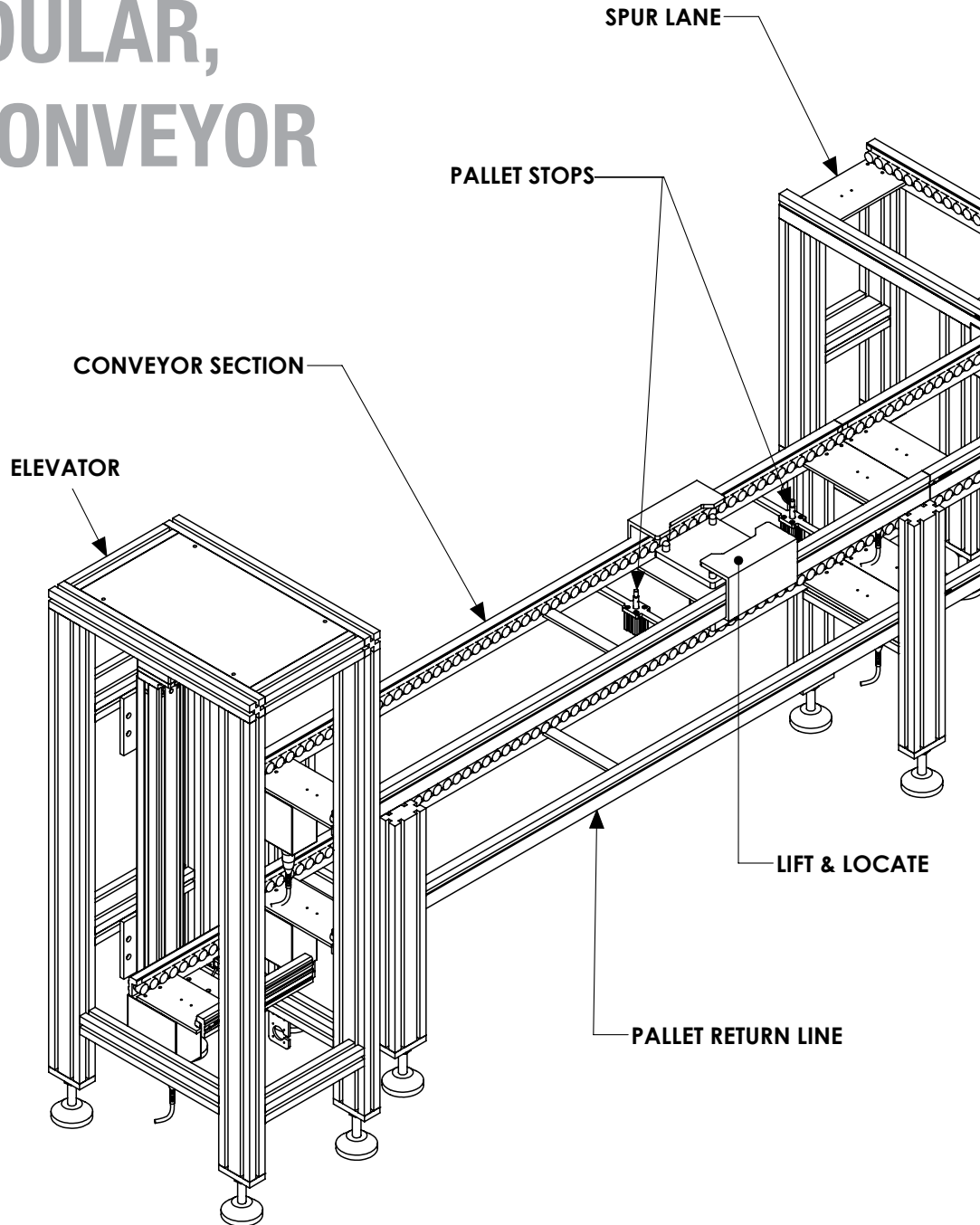

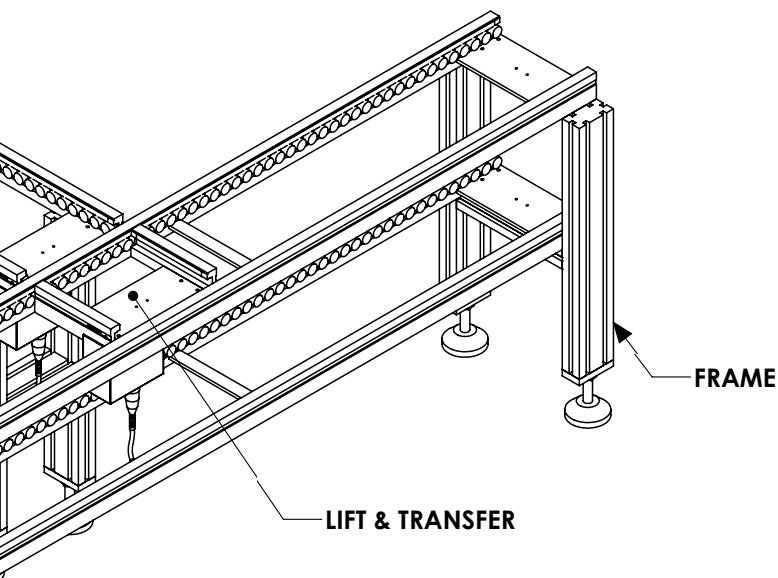

Process Integration

Quickdraw conveyors do more than move product from one place to another—they can be easily integrated into automated processes, such as robotic work cells. Their open center allows for easy application of auxiliary devices such as stops and lifts, while their low profile saves room in tight robotic work cells.

Modularity

Quickdraw conveyors come in modular sections, in a variety of lengths, making them easy to reconfigure to meet the changing needs of a manufacturing environment. These scalable, flexible systems allow for easy assembly line expansion and accommodate changes in conveyed product or processes.

Plus, Quickdraw's modularity allows automation work cells to be built and debugged individually. When each section is operational, you can line them up on the assembly floor for a fully functional assembly line in the most efficient way possible.

Design Time

Quickdraw modular conveyor systems are faster to design, resulting in rapid implementation on the plant floor. Conveyor designs are available online at www.qdraw.com. Here, Quickdraw conveyors can be quickly customized and files can be downloaded in a wide variety of 3D solid model and 2D drawing formats.

Power and Safety

Quickdraw conveyors use compact 24 VDC brushless motors to drive each section. This is not only safe—both electrically and physically—but economical to run. The low voltage power required can often be provided by associated automation equipment, saving the need for electricians to drop high voltage lines or install motor starter panels at the conveyor motor points.

Installation

Quickdraw customers routinely ship uniform conveyor modules to various automation integrators who specialize in each process. After the integrator tests the equipment and ensures all components are operational, the systems are shipped to the assembly floor and simply lined up to form the production line. This easy installation saves the time, trouble, and cost of having numerous technicians on the floor, debugging their equipment at service call rates that they knew they had to build in to their price proposals.

A Multi-purposed, Long-term Solution

Due to material selection, quality design, and features such as brushless motors and endless (as opposed to spliced) belts, Quickdraw conveyors have a very high MTBF (Mean Time Before Failure). Just as important, the modular, low profile conveyors offer a very low MTTR (Mean Time To Repair), most repairs can be accomplished in 10 minutes or less—meaning less downtime and lower repair costs.

In addition, with Quickdraw's modular design, they are very easy to repurpose and reuse in a new assembly application. Even the conveyor width can be changed by switching out as few as three components.

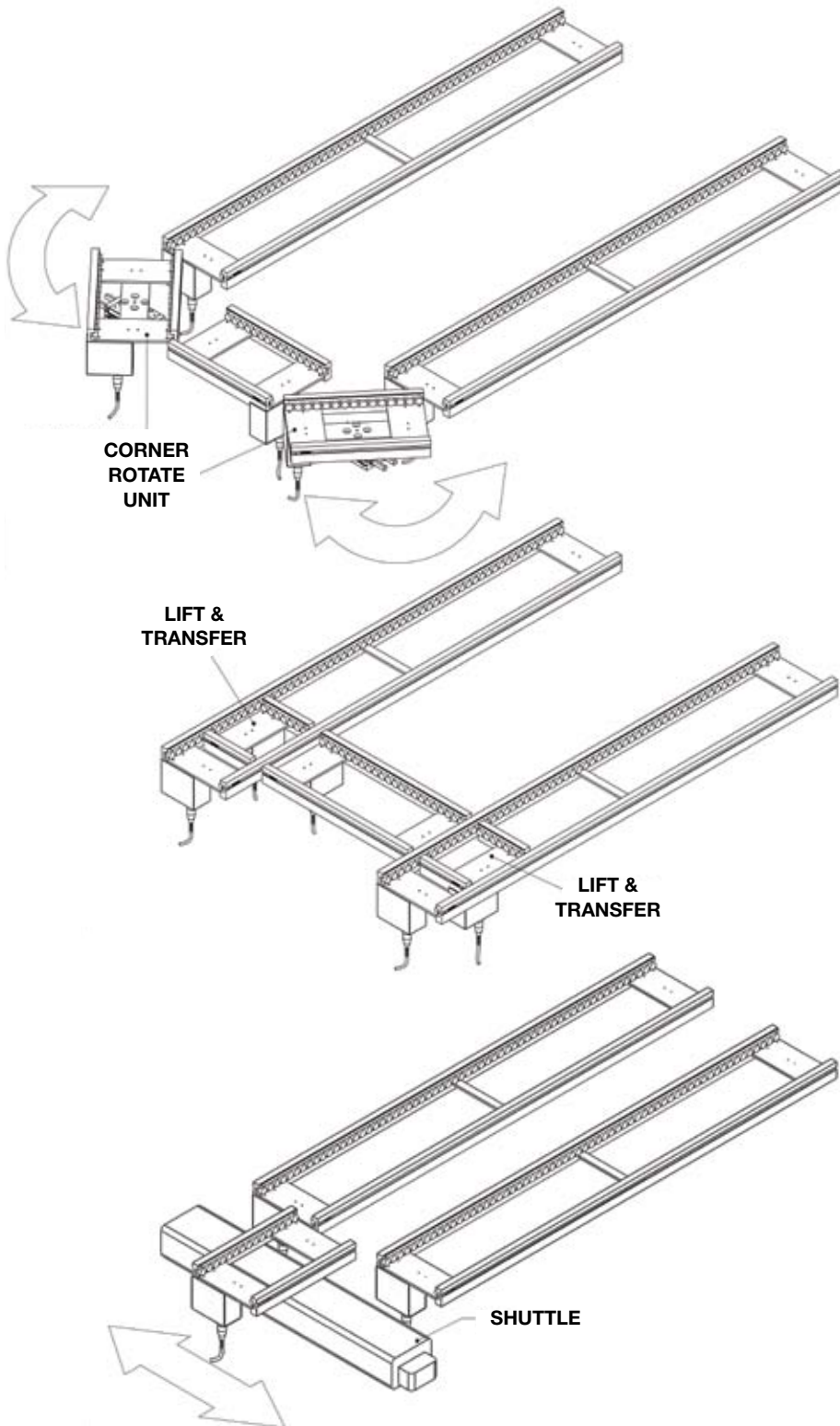

Quickdraw offers a variety of products for laying out an automation assembly line. Selection will depend on pallet orientation requirements, overall line size, and cycle time requirements.

CORNER ROTATE modules maintain the pallet leading edge as it travels through the assembly line.

LIFT & TRANSFER modules maintain the absolute pallet orientation as it travels through the assembly line. Typically, the perpendicular conveyor lanes will be at a slightly higher transfer elevation.

SHUTTLE TRANSFER modules maintain the absolute pallet orientation as it travels through parallel assembly lines. Shuttles may also be used in multi-lane operations.

LAYOUT *Configurations*

Quickdraw conveyors can be used in a variety of ways for laying out an assembly process. From automated robotic work cells; manual processes; and parallel and mixed-mode applications.

Quickdraw assembly lines can easily mix **manual and robotic** assembly processes on the same line. Lines can be commissioned with mixed processes, and manual workstations easily replaced by automation workstations as they are developed.

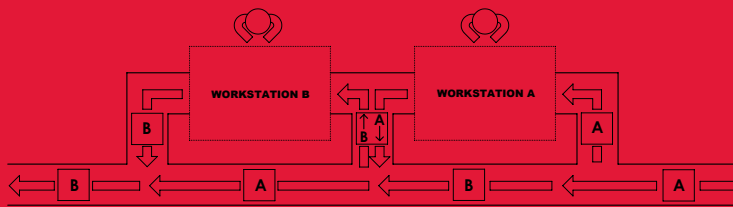
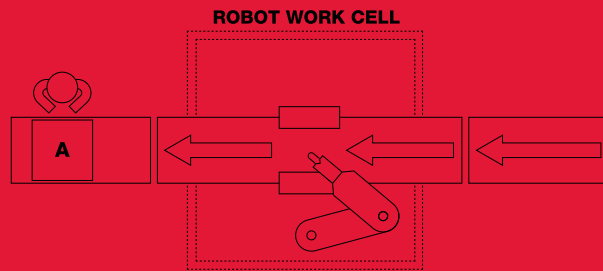

For maximum line flexibility, **Mixed-Mode Processes** can be handled directly on the main assembly line, or on spurs.

When a certain process takes more time than the average line cycle time, Quickdraw conveyors can manage the traffic requirements of multiple **Parallel Processes**.

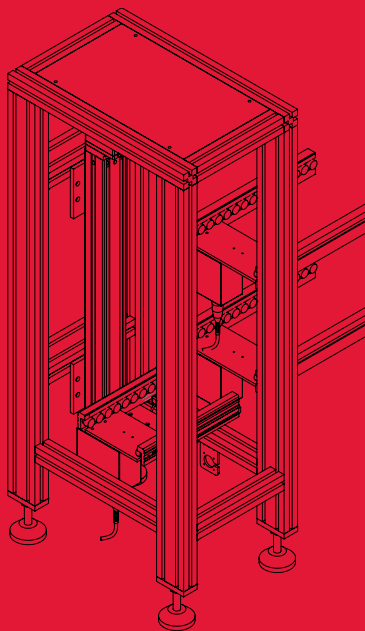
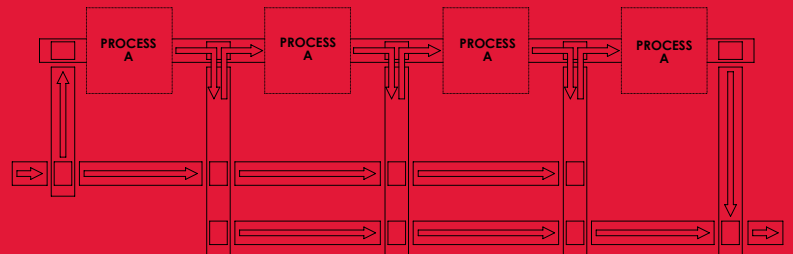

Quickdraw **Elevator** modules offer space-saving over/under line layouts. They can also be used for overhead pallet transfer and walk-under line access.

Quickdraw's engineers have been extremely helpful, offering us the flexibility to develop the conveyor solution we required.

*Brian Fitzloff
Manufacturing Engineer, Itron*

Quickdraw delivers the widest range of auxiliary devices to pair with your Quickdraw Conveyor System. Choose one or any combination of the following offerings to customize the material handling solution you need for your plant.

Connecting Your Workplace

More than just a manufacturer

Along with delivering industry-leading clean, modular automation conveyor solutions, Quickdraw provides the service and support you need to ensure your Quickdraw Conveyor System meets your every application requirement.

Quickdraw takes all your application parameters into consideration—from load sizes, to production speed, to plant floor configuration—when determining the best Quickdraw Conveyor System equipment, accessories, and configuration for your automation needs. Or, you can take the design process into your own hands—with a few simple clicks. At www.qdraw.com, you can enter in all your conveyor section parameters and see the section take shape, right on your computer screen.

Once your system is designed, Quickdraw will work with you to get your Quickdraw system up and running as efficiently as possible. And the service doesn't end with the engineering and installation. Quickdraw is with you every step of the way—offering maintenance and support, from your system's commissioning and throughout its service life.



Lift and Locate

The **Lift and Locate** Dock fastens directly to a Quickdraw conveyor section. Metering stops deliver the products or carriers one at a time into the dock. A fixture with locating pins mates with bushings in the product carrier, holding locations within ± 0.0035 inches of true position for precise operations. Quickdraw designs the lift plate to meet each product or pallet's specific requirements.

Lift and Rotate

The **Lift and Rotate** unit places the product in the orientation required by the operator or process equipment. It consists of a push/pull pneumatic cylinder with product detect sensor, a rotary pneumatic cylinder with two position sensors, and a lift pad that contacts the product or carrier.

Stops

The **Standard Metering Stop** consists of a pneumatically actuated pin and mounting block. The customer may specify the sensor style output and location. The **Cushioned Metering Stop** is a pneumatically or electrically actuated pin coupled with a shock absorber designed for impact sensitive products. Quickdraw also provides metering stops with a variety of **product detect sensors**, including fiber optic sensors, self-contained diffuse reflective sensors, and proximity switches.

Corner Rotate

The **Corner Rotate** is a Quickdraw conveyor on an independent frame mounted on a swivel base. A pneumatic cylinder actuates the rotating conveyor. Metering stops are positioned on the outfeed end of the incoming conveyor and the rotating conveyor. A product sensor is placed on the incoming end of the exit conveyor to prevent backed up product from interfering with the product that is being rotated.



AUXILIARY *Devices*

Stacking/Destacking

Quickdraw's fast, reliable, and flexible automated

Stacker/Destacker

dramatically improves the productivity of multiple applications in genomics, proteomics, drug research, and diagnostics. Quickdraw offers one of the fastest microplate stackers on the market, and it can now be used to integrate and automate third-party instruments. The speed is the result of Quickdraw Stacker's unique design: the plates can be delivered and stacked simultaneously.



Accumulation Buffer

The Quickdraw Conveyor **Accumulation Buffer** is designed to consume minimal floor space while providing valuable uninterrupted queue or curing time often required in the assembly of electronic components. The

buffer is capable of maintaining first in first out (FIFO) production sequence of product in automated assembly and accomplishes this in the most efficient automated format available.



Lift Gate

A **Lift Gate** provides operators simple access to the assembly line by allowing them to turn off the conveyor, raise it up, and walk through. This built-in device requires no expensive control panels, supervisory PLCs, or pneumatic distribution to operate.

Leg Sets

Leg Sets come in standard configurations but can also be designed to accommodate customer specifications. They are made from aluminum T-slot extrusion selected for its durability, design flexibility, and appearance. The sets may include swivel leveling feet and "L" base feet for mounting to the floor.

Shuttle

The **Shuttle** moves product from one lane to another, parallel lane. This can be an adjacent return lane, a lane shift, or converging or diverging lanes. It consists of a shuttle conveyor mounted to a pneumatic or electric actuator. Product arrives on the shuttle conveyor and stops. Then the actuator moves the shuttle conveyor to the new position, and the shuttle conveyor drives the product off in the desired direction.

Elevators

The **Product Elevator** offers the flexibility of variable infeed and outfeed heights. The elevator includes a metering stop and product sensor controlled by a PLC in the control enclosure.

The **Enclosed Lift Elevator** is designed for over/under assembly lines. It consists of a metering device at the infeed position, a powered infeed conveyor, a powered lift (carrier size) conveyor, and a vertical actuator that raises or lowers the lift to the outfeed



conveyor. Standard vertical lift capacity is 25 pounds. Cycle time is as low as 6 seconds. The elevator design shown above allows operators to walk under the conveyor for easy access to the assembly line, replacing bulky stair systems.

Quickdraw[®]

CONVEYOR SYSTEMS

Connecting Your Workplace

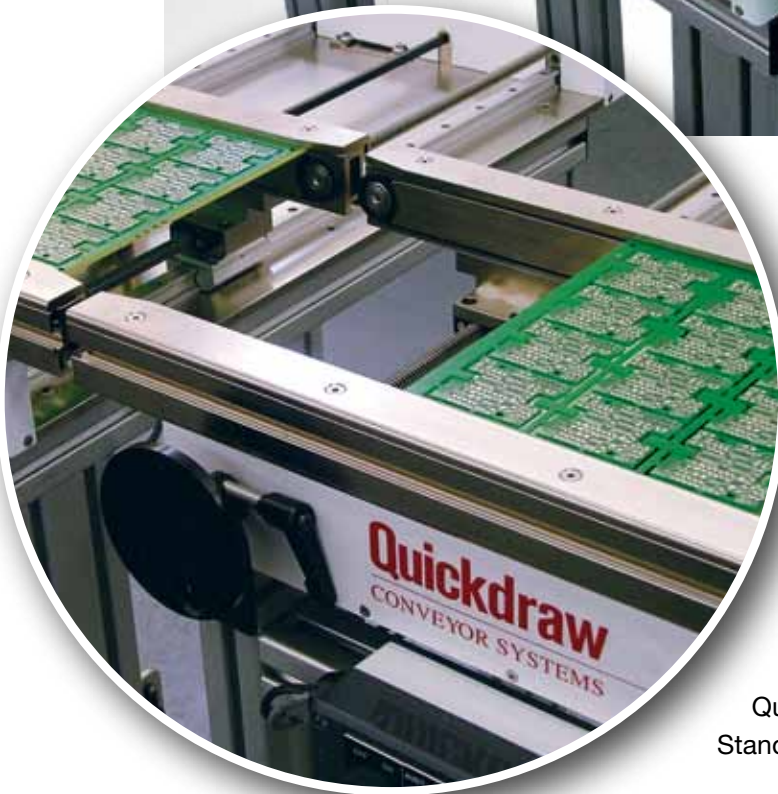

Q-Squared is Quickdraw's proprietary conveyor control platform. It provides Quickdraw Conveyors with built-in pallet transfer capability without the need for expensive control panels, custom software, or metering stops. It's especially well-suited as a transfer conveyor for use between workstations on printed circuit board and palletized assembly lines. The Q-Squared option is available on Quickdraw's Edge-Belt, HD, XR, and Standard MR roller conveyor lines.

Q-Squared

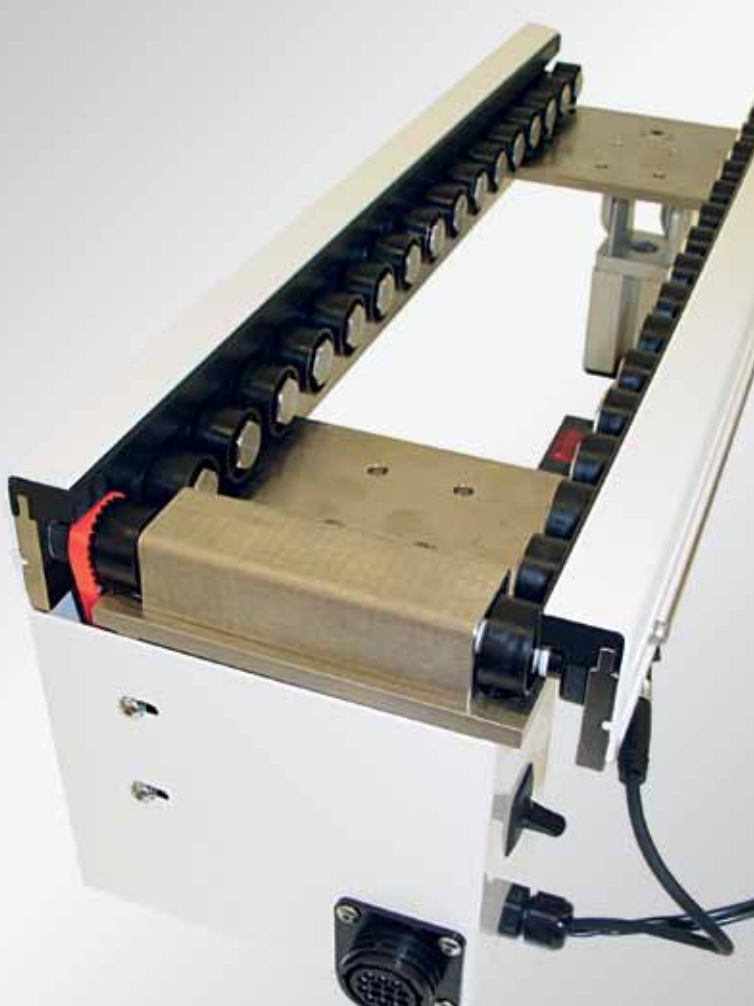
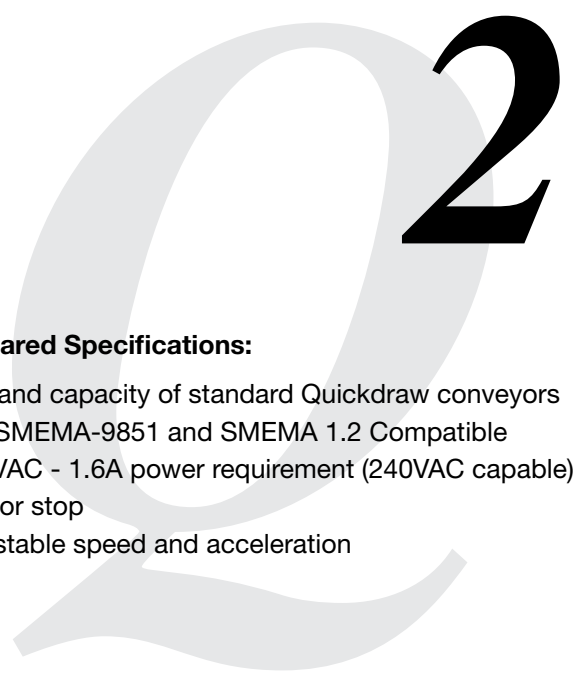

Q-Squared Specifications:

- Size and capacity of standard Quickdraw conveyors
- IPC-SMEMA-9851 and SMEMA 1.2 Compatible
- 110 VAC - 1.6A power requirement (240VAC capable)
- Sensor stop
- Adjustable speed and acceleration



Q-Squared offers significant cost savings over other transfer systems by eliminating the need for control panels, supervisory PLCs, and complex pneumatic distribution. The system offers true modular plug and play operation, with SMEMA capability and Audit/Bypass function included and adjustable width optional. Q-Squared can also control Corner Rotate, Shuttle, Elevator, and Lift Gate functions without the need of a control panel with PLC. Besides transfer conveyors between workstations, Q-Squared works well as a buffering return line on palletized assembly lines.

MR

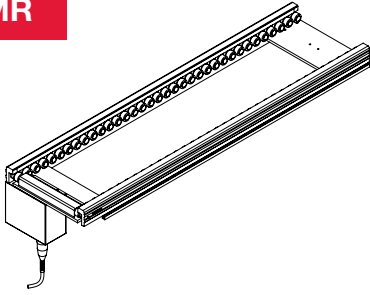

XR

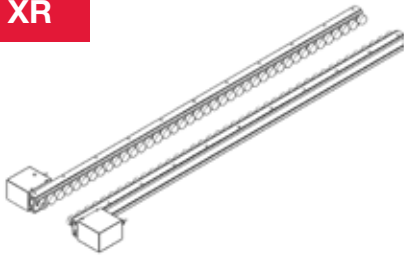

- A. Pallet Control Features
- B. Singulation Pocket
- C. Locating Bushings
- D. Toolplate Interface

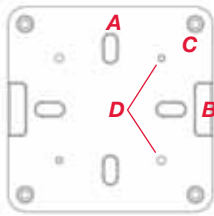

MR Conveyors

	WIDTH	MTP 3.92" (9.96 cm)	GWE 6.06" (15.39 cm)	TCM 10.04" (25.50 cm)
LENGTH	11" (28 cm)	88111011	88112011	88113011
	39" (99 cm)	88111039	88112039	88113039
	60" (152 cm)	88111060	88112060	88113060

XR Conveyors

	WIDTH	Customer Specified
LENGTH	60" (152 cm)	88120060
	78" (198 cm)	88120078
	120" (305 cm)	88120120

Product Carriers

	WIDTH	MTP	GWE	TCM
ALUMINUM		88311000	88321000	88331000
PLASTIC		88312000	88322000	88332000

ACCESSORIES

PRODUCT

- Metering stop 88201000
- Cushioned metering stop 88202000
- Product detect sensors (PNP) 88203000
- Piston detect sensors 88204000
- Leg set (37.5" ± 1" height) 88205000
- Pawl catch 88206000
- Lift and Locate (MTP) 88207100
- Lift and Locate (GWE) 88207200
- Lift and Locate (TCM) 88207300

THE QUICKSHIP PROGRAM was designed by Quickdraw to provide customers with the material handling solutions they need as time efficiently as possible, offering rapid ordering and delivery of standard Quickdraw MR and XR conveyor versions. With the Quickship program, conveyor systems are built and shipped from Quickdraw's facility within one week of the customer's order.

Standard MR options include any combination of three commonly specified conveyor lengths and three common widths, as well as a choice of several standard pallet designs to accompany the conveyor system. XR conveyors ordered through the Quickship program are available in two lengths with a customer defined width. Plus, leg sets and other accessories can be added to these standard conveyor systems upon request.*

*Adding accessories to a conveyor system may extend the delivery time. Contact Quickdraw for more information.

Connecting Your Workplace



GREEN EFFICIENCY

Quickdraw[®]

CONVEYOR SYSTEMS